

Freeflow[®]

RAINWATER SYSTEMS



Freefoam
LIFETIME
Guarantee

 **freefoam**
Building Products

CONTENTS

INTRODUCTION	2-3
FREEFLOW RAINWATER SYSTEMS	4-17
Square Line Rainwater System	4-6
Half-Round Rainwater System	7-9
Ogee Rainwater System	10-12
Deep Rainwater System	13-14
Cast Iron Style Rainwater System	15-17
INSTALLATION GUIDE	18-20

FREEFLOW®

Freeflow is a range of innovative, high quality PVC-U rainwater systems that are the result of Freefoam's culture of continuous innovation and investment in research and development. The Freeflow range has been designed to ensure both reliable, leak-free performance and quick installation. In addition, it is compatible with other rainwater systems with a range of adaptors. Freeflow products come in a range of standard colours including white, black and brown.

MAJOR BENEFITS

► Coextruded to Reduce Main Cause of Leaks

Each rainwater system is co-extruded with a white interior and a range of exterior colours - Freefoam's new innovative solution to the problems associated with rapid heat absorption and expansion of gutters. Widely published test results show that while a white surface exposed to sunshine can absorb heat and attain a surface temperature 10°C or more over the air temperature, dark surfaces can rise a further 30-40°C and exceed the softening point of the PVC. On large capacity gutters with a large surface area facing the sun, this can be a particular problem. While the interior will be exposed to sunlight as normal, its absorption of heat from the sun and subsequent expansion along its width and length will be significantly reduced, thus dramatically decreasing the probability of any associated problems.



► Long-life Advanced Compressible Seals for Water-tight Joints

All Freeflow® gutter accessories are manufactured with our advanced long-life compressible seals which results in flexible water-tight joints when lengths of guttering are connected together. The seals also allow the gutters to move without making a noise and without creating the gaps which cause leaks.



► Lifetime Guarantee provides Customers with Significant Competitive Advantage

A 50 Year Lifetime Guarantee is available on all registered white Freeflow installations, while a 10 year guarantee is available on all other colours. Customers not availing of the online registration system to obtain a certificate will qualify for the standard 20 year guarantee on all white products. All guarantees are subject to terms and conditions (see www.myfreefoam.com for details).



➤ **Protective Film on All Gutters and Downpipes to Avoid Scratches**

All Freeflow gutters and downpipes come covered with protective film so they can survive knocks in transit and can be installed without scratches.



➤ **Environmentally Sustainable System**

Freeflow® rainwater systems are manufactured using a combination of recycled and virgin materials to minimise environmental impact and optimise product performance. Recycled content varies, however it is typically up to 85%. All recycled material used is 100% lead free Freefoam material.



➤ **Complete Range of Roofline Products**

Freefoam offers a fully integrated suite of products. In addition to the Freeflow rainwater range, Freefoam also produces a comprehensive range of roofline products providing a complete solution based around products that are designed to work together.



SQUARE LINE RAINWATER SYSTEM (114mm/65mm)

BSEN 12200 (Downpipes and fittings)
 BSEN 607 (Gutters and fittings)
 BSEN 1462 (Eaves brackets)

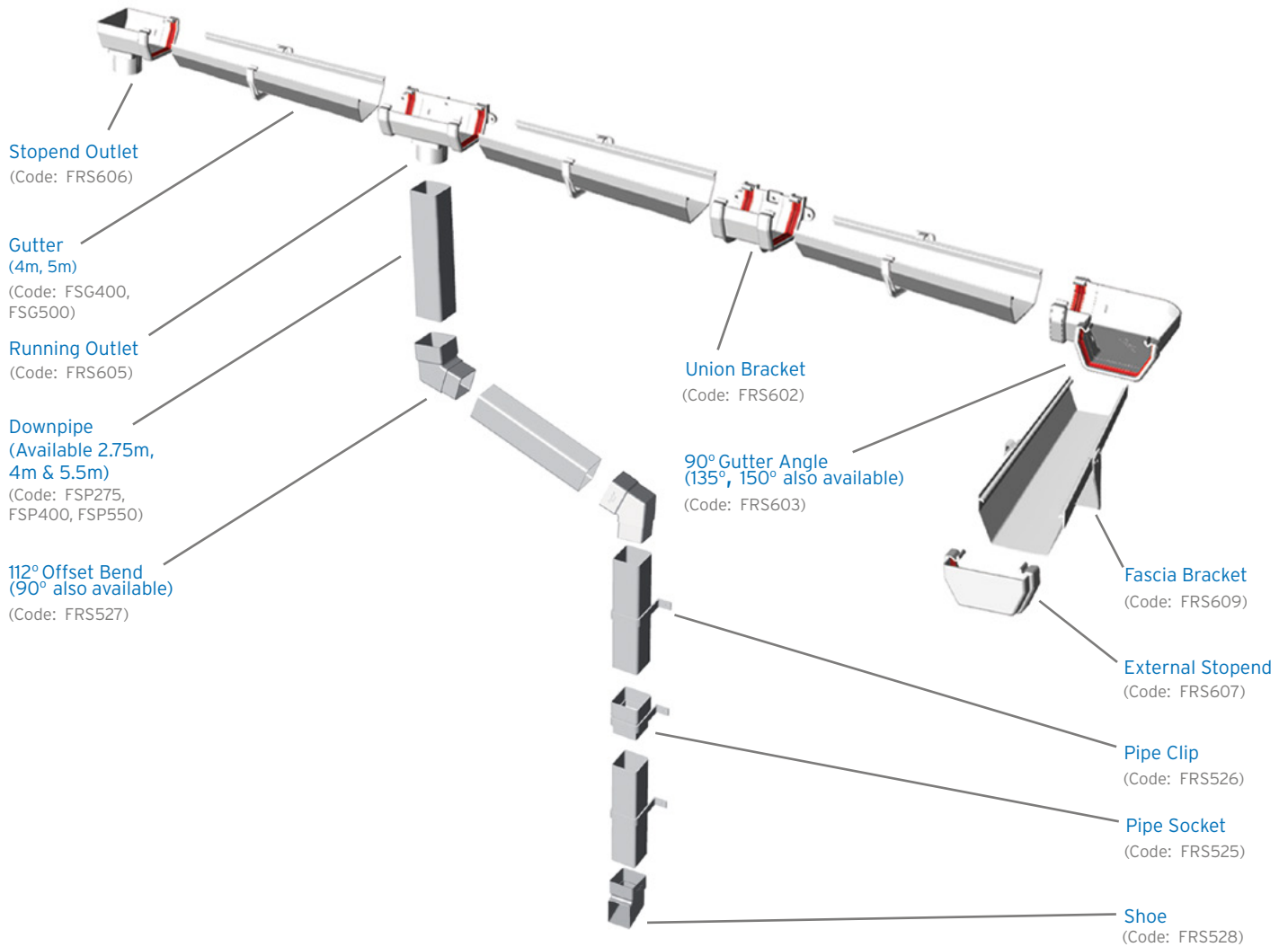

Dimensions (mm)

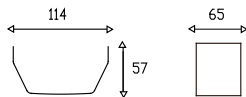

Colours

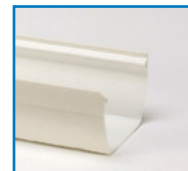
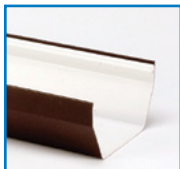

	DESCRIPTION	CODE	COLOURS	BOX ¹ /PACK QUANTITIES
	Gutter ² (4m, 5m)	FSG400 FSG500	White Black Brown	6
	150° Gutter Angle	FRS601	White Black Brown	24/1
	Union Bracket	FRS602	White Black Brown	24/6
	90° Gutter Angle	FRS603	White Black Brown	20/1
	135° Gutter Angle	FRS604	White Black Brown	24/1
	Running Outlet	FRS605	White Black Brown	16/1
	Stopend Outlet	FRS606	White Black Brown	30/1
	Stopend-External	FRS607	White Black Brown	135/15
	Stopend-Internal	FRS608	White Black Brown	200/10
	Square Fascia Bracket	FRS609	White Black Brown	150/25
	Square to Round Gutter Adaptor	FRS611	White Black Brown	55/11
	Ogee to Square Gutter Adaptor	FRO611	White Black Brown	1/1

¹ Please order in box quantities if possible.

² Square or round pipe systems may be fitted to the square line gutter system.

	DESCRIPTION	CODE	COLOURS	BOX ¹ /PACK QUANTITIES
	Pipe (2.75m;4m;5.5m)	FSP275 FSP400 FSP550	White Black Brown Caramel	6 6 6
	90° Offset Bend	FRS524	White Black Brown Caramel	40/10
	Socket	FRS525	White Black Brown Caramel	50/10
	Square Pipe Clip (Stand-off)	FRS526	White Black Brown Caramel	200/10
	Square Pipe Clip (Flush)	FRS536	White Black Brown Caramel	240/30
	112° Offset Bend	FRS527	White Black Brown Caramel	30/1
	Square Shoe	FRS528	White Black Brown Caramel	56/14
	112° Branch	FRS529	White Black Brown Caramel	20/10
	Square to Round Downpipe Adaptor	FRS531	White Black Brown Caramel	50/10
	Mini Offset	FRS532	White Black Brown Caramel	20/10
	Access Pipe	FRS533	White Black Brown Caramel	5/5

¹ Please order in box quantities if possible.

HALF ROUND RAINWATER SYSTEM

(112mm/68mm)

BSEN 12200 (Downpipes and fittings)
 BSEN 607 (Gutters and fittings)
 BSEN 1462 (Eaves brackets)
 BSEN 4576 (Half round gutters & pipes)

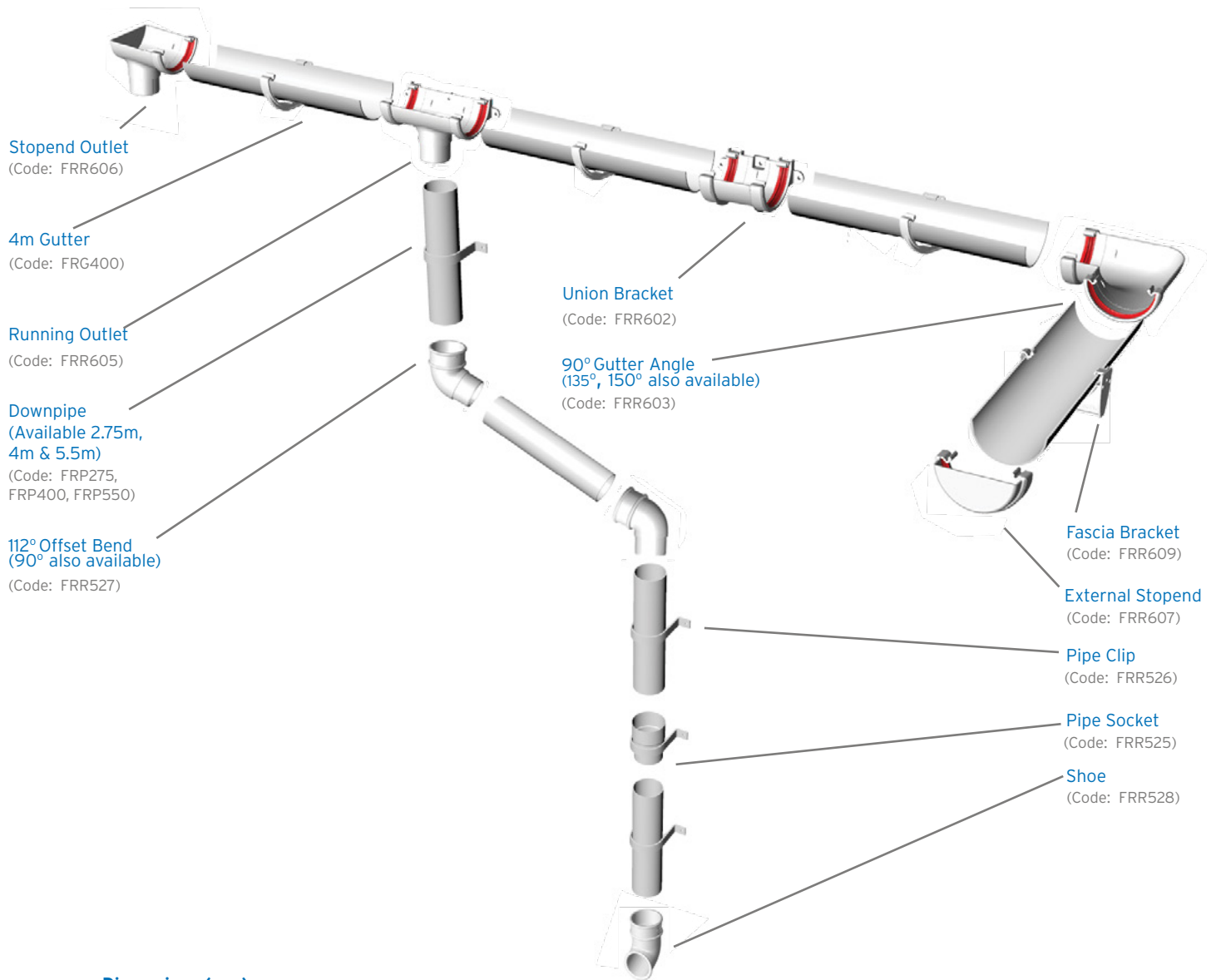

Dimensions (mm)

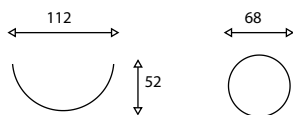



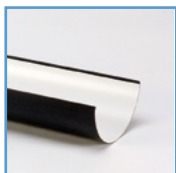







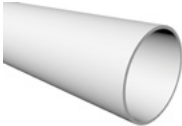

Colours

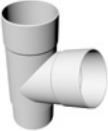

	DESCRIPTION	CODE	COLOURS	BOX ¹ /PACK QUANTITIES
	4m Gutter ²	FRG400	White Black Brown	6
	150° Gutter Angle	FRR601	White Black Brown	28/1
	Union Bracket	FRR602	White Black Brown	30/06
	90° Gutter Angle	FRR603	White Black Brown	22/1
	135° Gutter Angle	FRR604	White Black Brown	30/1
	Running Outlet	FRR605	White Black Brown	18/1
	Stopend Outlet	FRR606	White Black Brown	30/1
	Stopend-External	FRR607	White Black Brown	120/15
	Stopend-Internal	FRR608	White Black Brown	270/30
	Half Round Fascia Bracket	FRR609	White Black Brown	180/30
	Square to Round Gutter Adaptor	FRS611	White Black Brown	1/1
	Ogee to Round Gutter Adaptor	FRR611	White Black Brown	1/1

¹ Please order in box quantities if possible.

² Square or round pipe systems may be fitted to the half round gutter system.

	DESCRIPTION	CODE	COLOURS	BOX ¹ /PACK QUANTITIES
	Pipe (2.75m;4m;5.5m)	FRP275 FRP400 FRP550	White Black Brown	6 6 6
	90° Offset Bend	FRR524	White Black Brown	40/10
	Socket	FRR525	White Black Brown	50/10
	Round Pipe Clip (Stand-Off)	FRR526	White Black Brown	180/30
	Round Pipe Clip (Flush)	FRR536	White Black Brown	100/10
	112° Offset Bend	FRR527	White Black Brown	36/9
	Shoe	FRR528	White Black Brown	40/10
	112° Branch	FRR529	White Black Brown	20/10
	Hopper	FRR530	White Black Brown	5/5
	Mini Offset	FRR532	White Black Brown	10/1
	Access Pipe	FRR533	White Black Brown	5/5
	Round Clip (Stand-off)	FRR534	White Black Brown	5/5
	Round Joiner	FRR535	White Black Brown	5/5

¹ Please order in box quantities if possible.

OGEE RAINWATER SYSTEM

(135mm/65mm/68mm)

BSEN 12200 (Downpipes and fittings)

BSEN 607 (Gutters and fittings)

BSEN 1462 (Eaves and brackets)

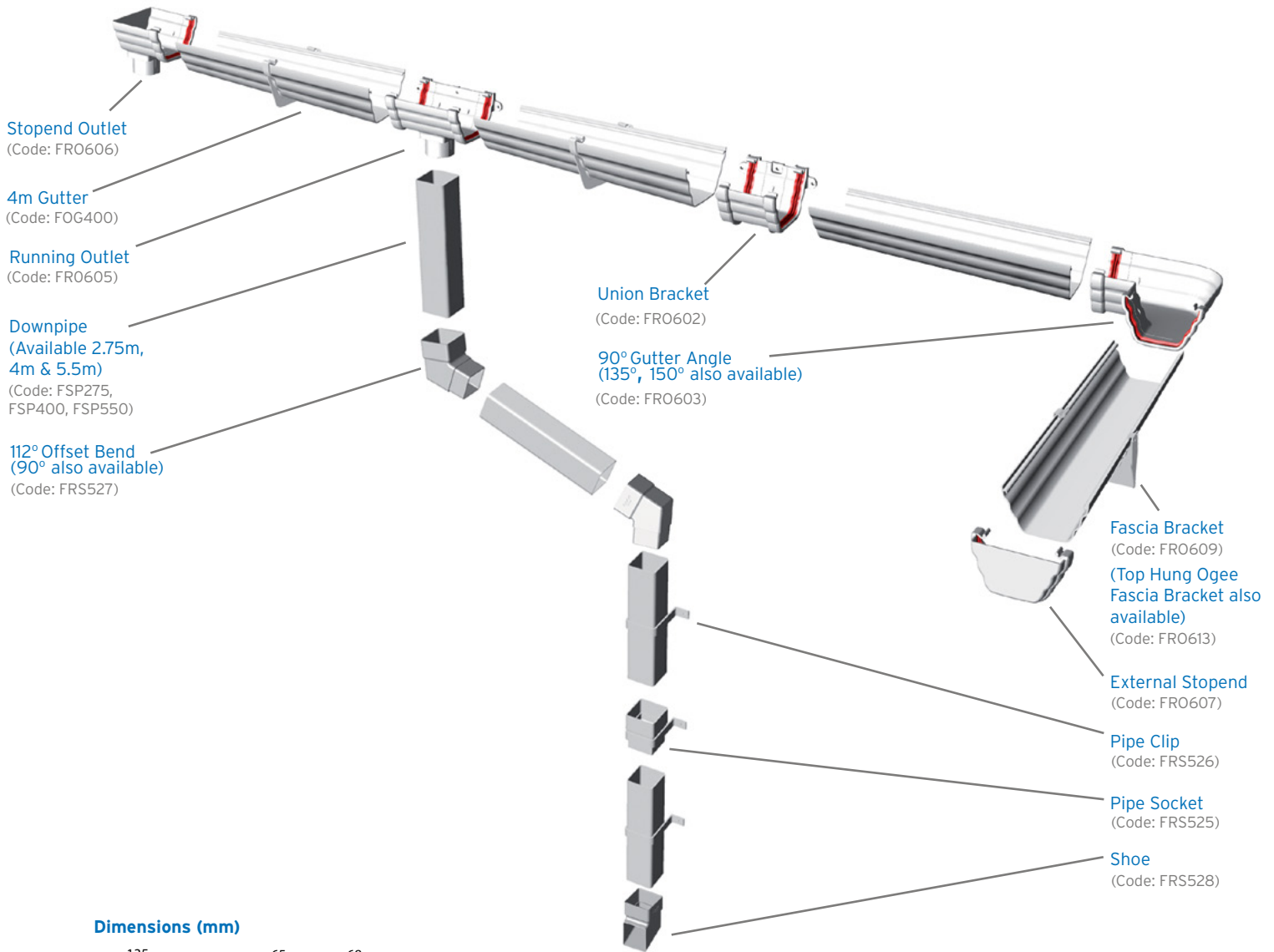

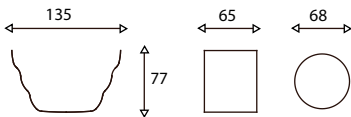

Dimensions (mm)



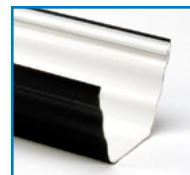
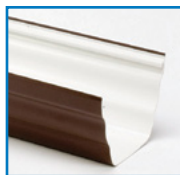

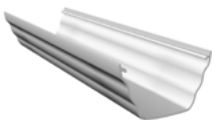
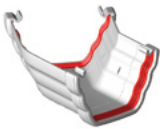
Colours



	DESCRIPTION	CODE	COLOURS	BOX ¹ /PACK QUANTITIES
	Gutter (4m) ²	FOG400	White Black Brown Caramel	6
	150° Gutter Angle	FRO601	White Black Brown Caramel	10/1
	Union Bracket	FRO602	White Black Brown Caramel	20/1
	90° Gutter Angle	FRO603	White Black Brown Caramel	10/1
	135° Gutter Angle	FRO604	White Black Brown Caramel	12/1
	Running Outlet	FRO605	White Black Brown Caramel	12/1
	Stopend Outlet	FRO606	White Black Brown Caramel	20/1
	Stopend-External	FRO607	White Black Brown Caramel	80/10
	Stopend-Internal	FRO608	White Black Brown Caramel	50/10
	Ogee Fascia Bracket	FRO609	White Black Brown Caramel	100/10

¹ Please order in box quantities if possible.

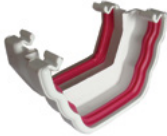
² Square or round pipe systems may be fitted to the ogee gutter system.

	DESCRIPTION	CODE	COLOURS	BOX ¹ /PACK QUANTITIES
	Ogee to Square Gutter Adaptor	FRO611	White Black Brown Caramel	1/1
	Ogee to Round Gutter Adaptor	FRR611	White Black Brown Caramel	1/1
	Top Hung Ogee Fascia Bracket	FRO613	White Black Brown Caramel	150/30

DEEP RAINWATER SYSTEM

(116mm/68mm)

BSEN 12200 (Downpipes and fittings)

BSEN 607 (Gutters and fittings)

BSEN 1462 (Eaves and brackets)

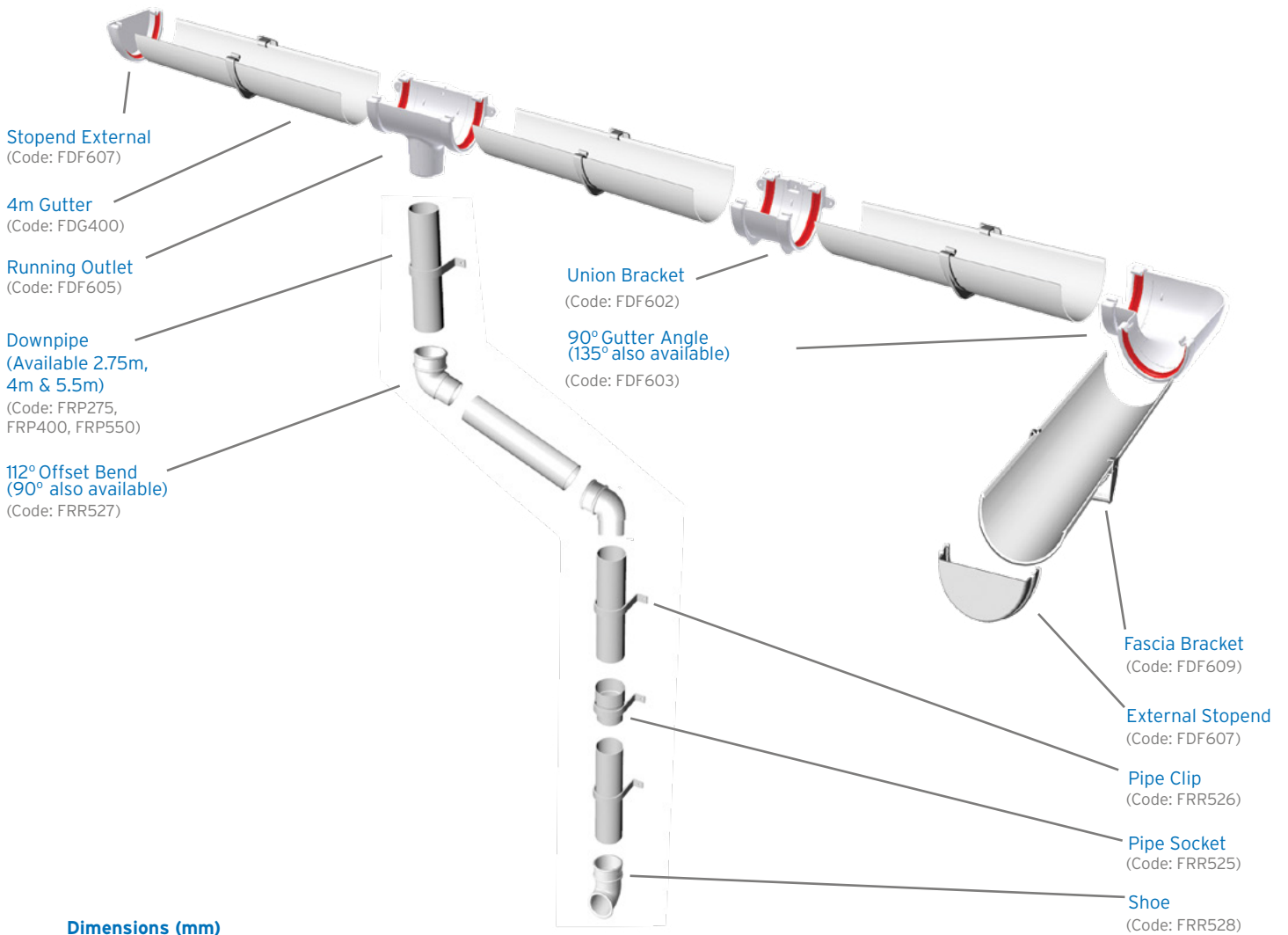

Dimensions (mm)

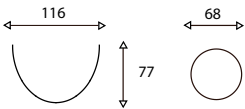

Colours

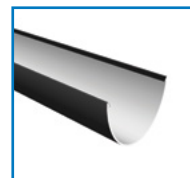
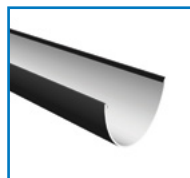
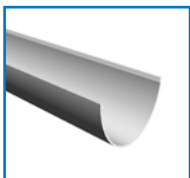

	DESCRIPTION	CODE	COLOURS	BOX ¹ /PACK QUANTITIES
	Gutter (4m) ²	FDG400	White Black Brown	6
	Union Bracket	FDF602	White Black Brown	26 (2x10, 1x6)
	90° Gutter Angle	FDF603	White Black Brown	15/1
	135° Gutter Angle	FDF604	White Black Brown	18/1
	Running Outlet	FDF605	White Black Brown	12/1
	Stopend-External	FDF607	White Black Brown	96/12
	Stopend-Internal	FDF608	White Black Brown	300/20
	Fascia Bracket	FDF609	White Black Brown	150/25

¹ Please order in box quantities if possible.

² Square or round pipe systems may be fitted to the deep gutter system.

CAST IRON STYLE RAINWATER SYSTEM

The new Freeflow® Cast Iron Style Rainwater System has been designed to provide the authentic look and feel of traditional cast iron rainwater systems with all the benefits of a modern, low-maintenance and fitter-friendly system. The system is available in half round and deep styles with a full range of related accessories to ensure a neat and professional installation.



	DESCRIPTION	CODE	COLOURS	BOX ¹ QUANTITY
	4 metre Round Gutter	FRG400CBL	Cast Iron Black	6
	Round Union Bracket	FRR602CBL	Cast Iron Black	20/1
	Round 90° Gutter	FRR603CBL	Cast Iron Black	10/1
	Round Running Outlet	FRR605CBL	Cast Iron Black	12/1
	Round Stopend Outlet	FRR606CBL	Cast Iron Black	20/1
	Round Stopend - External	FRR607CBL	Cast Iron Black	80/10
	Round Fascia Bracket	FRR609CBL	Cast Iron Black	100/10
	Round 112° Offset Bend	FRR527CBL	Cast Iron Black	36/9
	Round 112° Branch	FRR529CBL	Cast Iron Black	20/10

¹ Please order in box quantities if possible.

	DESCRIPTION	CODE	COLOURS	BOX ¹ QUANTITY
	4m Deep Gutter	FDG400CBL	Cast Iron Black	6
	Deep Union Bracket	FDF602CBL	Cast Iron Black	24/6
	Deep 90° Bend	FDF603CBL	Cast Iron Black	20/1
	Deep Running Outlet	FDF605CBL	Cast Iron Black	16/1
	Deep External Stop End	FDF607CBL	Cast Iron Black	135/15
	Deep Fascia Bracket	FDF609CBL	Cast Iron Black	150/25
	Round Pipe (2.75m; 5.5m)	FRP275CBL FRP550CBL	Cast Iron Black	6 6
	Half Round Pipe Clip - Stand-off	FRR534CBL	Cast Iron Black	64/8
	Round Joiner	FRR535CBL	Cast Iron Black	45/9
	Round Shoe	FRR528CBL	Cast Iron Black	40/10

¹ Please order in box quantities if possible.

INSTALLATION GUIDE

Freeflow[®] rainwater systems, of square, half round, ogee or deep design, may be installed using the steps outlined below. It is important that you refer to the design guidelines outlined at the end of this installation guide prior to beginning your installation project. The design guidelines, exploded view drawings and product lists in this brochure will assist you in selecting the correct type and quantity of products required.

FITTING GUTTER

- 1 It is important to ensure gutters are fitted as high as possible to the roof edge and the roof edge should not project beyond the centre of the gutter cross section. Gutters can be fitted either level or with a slight fall. Laying the gutter with a fall will increase the flow capacity and increase the area of the roof that can be drained. Silting will also be reduced with a gutter installed with a slight fall.
- 2 Fix the gutter outlet to the fascia with Size 6 (minimum) roundhead screws* vertically above the gully from which the rainwater will be conveyed to the drainage system. Use a string-line to ensure a straight gutter, whether level or laid to a fall. Double check the desired fall is achieved, adjust as necessary. Mark out the position of every support point along this line.
- 3 Fix fascia brackets to the fascia along the line created above with Size 6 (minimum) roundhead screws* at maximum intervals of 1m. A fascia bracket should be fitted within 150mm of all stopends and angles.
- 4 The fitting of a union bracket is required at each junction of two gutter sections. Fit a stopend to complete the run. Union brackets should be fixed to the fascia with Size 6 (minimum) roundhead screws*. Unions should never be allowed to 'float' without fixing.
- 5 Starting at the gutter outlet insert the back edge of the gutter under the retaining lip of the fascia brackets. Then press down on the gutter to snap the front of the gutter in place. Fit additional gutter lengths and gutter lengths cut to size as required. When measuring gutters to be fitted, ensure that the gutter will extend to the marks on the fittings. Fittings are marked to indicate the position to which the gutter should be inserted to allow for thermal expansion.
- 6 All rainwater gutters and pipes must be squarely cut and all burrs removed. It is recommended that a fine toothed saw be used. Care must be taken when cutting gutters and pipes in cold or damp conditions.

NOTE: In areas subject to high winds, extra securing of brackets may be required. Any extra screws deemed advisable should only be secured through holes drilled with the necessary clearance.

FITTING DOWNPIPE

- 1 Fixing of the downpipe starts at the gutter outlet. An offset is generally required to join the gutter outlet or downpipe from the outlet to the downpipe on the wall. Offsets can be constructed from the range of Freeflow bends depending upon the roof overhang. All offsets should be supported directly beneath the lower offset bend by a pipe clip. Remember to allow for thermal expansion as described below.
- 2 Insert a length of square or round downpipe as preferred into the bottom of the offset bend and fix a pipe clip to the wall with Size 6 (minimum) roundhead screws*. Ensure that a gap of 10mm is left at the top of the downpipe for thermal expansion. Fix additional pipe clips as required at maximum intervals of 2m. If the downpipe is subject to impact, extra clips should be considered. Two different pipe clip fittings are available, a flush fitting and where a gap is preferable between wall and pipe, a stand off clip.
- 3 Additional lengths of downpipe may be required to reach the ground depending on the height of the building. In this case, fix a socket to the wall with a pipe clip and Size 6 (minimum) roundhead screws* at the bottom of the existing fitted downpipe and fix another length of downpipe to the wall as outlined above. Ensure that a gap of 10mm is left at the top of additional downpipes for thermal expansion.
- 4 When all downpipes have been fixed in place, connection to the drainage system can be achieved either by terminating the downpipe with a rainwater shoe for disposal either into a drain or hopper or directly into the underground drainage pipe using a rainwater pipe adaptor. The shoe or adaptor will take the rainwater from the downpipe to the drain thus reducing the possibility of surface water accumulating on the ground.

Notes:

- 1 *All screws should be non-corroding, zinc-plated, stainless steel or similar.
- 2 In areas prone to heavy snow falls, fascia brackets should be fixed at maximum intervals of 800mm with two Size 6 (minimum) roundhead screws*.
- 3 Where, due to the absence of a fascia or the design of the building, support brackets cannot be fixed, Freefoam offer a range of rafter brackets to suit each profile that is screwed to the rafter. Where a gradient is required, rise and fall brackets can be used.
- 4 Freefoam supply a range of gutter adapters to connect to existing gutter systems. All adapters must be supported at either side of the connection. It is recommended that the joint be secured by a suitable waterproof sealant.

TESTING

When rainwater installations are complete the system should be tested for water tightness under working conditions and internal downpipes should also be tested as prescribed in the relevant Building Regulations. Guidance is also given in BS6367:1983.

IMPORTANT NOTE

This advice and guidance is based upon typical situations only. For assistance with specific projects, please contact Freefoam Technical Services at info@freefoam.com.

BRITISH STANDARDS

Freeflow Rainwater systems are manufactured to the following British Standards:

BS4576: - Half round gutters and pipes of circular cross section manufactured in PVC-U.

BS EN 12200 - Plastics rainwater systems for above ground external use manufactured in PVC-U.

BS EN 607 - Eaves gutters and fittings made of PVC-U definitions, requirements and testing.

BS EN 1462 - Brackets for eaves gutters - requirements and testing.

TECHNICAL ADVICE AND GUIDANCE

An advisory service is available to offer technical assistance and installation details. For technical advice, email the following address: info@freefoam.com.

Whilst every effort is made to ensure details are accurate and up to date our continual product development and improvement programme may cause details to change.

MAINTENANCE

Gutters and downpipes should be cleaned out regularly, at least annually, more frequently in locations where there is wind borne debris, e.g. close to trees and sandy areas. A mild detergent solution is ideal when cleaning dirt from external surface areas.

Regularly check the security of gutters, downpipes, fittings to ensure they have not been dislodged or come loose and that the gutter extrusions have not moved beyond any thermal expansion allowance marks in the fittings.

DESIGN

Rainfall Intensity: Rainfall intensity in the UK and Ireland varies with location, however, a maximum of 75mm per hour is usually taken when calculating the discharge requirements for gutter and downpipe systems.

Snow Loading: BS 6367:1983 sets out the design requirements for snow loading. In areas where heavy snowfalls can be expected support brackets should be fixed at a maximum of 800mm centres.

Roof Drainage Requirements: The amount of water collected by a roof area will determine the choice of gutter system to use and the positioning of the outlets. It is necessary first to calculate the effective roof area.

Effective Roof Area (ERA): The formula is:

$$ERA = (B+C/2) \times L$$

Where B=half the roof span (m)

C=ridge to eaves height (m)

L=gutter length (m)

Rainwater Run Off (Flow): To calculate flow in litres per second for 75mm/hour rainfall intensity the formula is:

ERA (square metres) x 0.0208

Gutter Flow Capacity: The draining capacity of Freeflow rainwater systems is determined by the gutter gradient (fall) and the size and positioning of the outlets; best results are obtained with the outlet at the centre of the longest run of gutter. Additionally, if a gutter angle is introduced into the rainwater gutter run the effective gutter flow capacity is reduced.

Table 1. Gutter flow capacity with outlet at the centre of the gutter run.

System	Gutter level	1:600 gradient
Half round	1.90 litres/sec	2.43 litres/sec
Square	2.20 litres/sec	3.03 litres/sec
Ogee	3.90 litres/sec	4.76 litres/sec
Deep	3.77 litres/sec	4.60 litres/sec

Table 2. Gutter flow capacity with outlet at the end of the gutter run.

System	Gutter level	1:600 gradient
Half round	0.95 litres/sec	1.21 litres/sec
Square	1.10 litres/sec	1.55 litres/sec
Ogee	1.92 litres/sec	2.36 litres/sec
Deep	1.87 litres/sec	2.29 litres/sec

Rainwater Compatibility Chart

Manufacturer	112mm Half Round	Square Line
Brett Martin	✓	✓
FloPlast	✓	✓
Terrain (Polypipe)	✗	✗
Hepworth (Wavin)	✓	✓
Hunter	✓	✓
Kalsi	✓	✓
Marley (Aliaxis)	✓	✗
Marshall Tufflex (Polypipe)	✓	✓
Osma (Wavin)	✓	✗
Polypipe	✓	✓

NOTES

Note: All specifications, dimensions, descriptions and illustrations contained in any Freefoam sales literature, quotation, or pricelist or other advertisement matter are intended merely to present a general idea of the goods that we sell. We reserve the right from time to time to make changes which are required to comply with any applicable safety or statutory requirements or which do not materially affect the quality or fitness for purpose of the goods you purchase from us.

www.freefoam.com
sales@freefoam.com

Freefoam Plastics
Central Commercial Park
Centre Park Road
Cork
IRELAND

T 021 496 6311
F 021 496 5273

Freefoam Plastics
77-83 St James Mill Road
Northampton
NN5 5JP
UK

T 01604 591110
F 01604 580299

February 2014